Operating instructions and spare parts list

OptiGun GA03

Automatic powder gun

CE 0102 Ex II 2D



Translation of the original operating instructions

Table of contents

About this instructions	3
General information	3
Keeping the manual	3
Safety symbols (pictograms).....	3
Presentation of the contents	4
Figure references in the text	4
Safety	5
General information	5
Intended use	5
Product specific safety information	6
Product description	7
Field of application	7
Utilization.....	7
Reasonably foreseeable misuse.....	7
Technical Data	8
Electrical data	8
Dimensions	8
Processible powders	8
Design and function	9
Scope of delivery	9
Available accessories	9
SuperCorona ring.....	10
Principle of operation	12
High voltage generation	12
Circuit.....	12
Powder flow and electrode rinsing air	12
Spray nozzle	13
Typical characteristics – properties of the functions	14
Powder hose quick release connection	14
Connection for SuperCorona Ring.....	14
Start-up	15
Preparation for start-up	15
Basic conditions	15
Connect the OptiGun automatic powder gun.....	15
Initial start-up	17
Operation	18
Setting of total air	18
Setting the powder quantity	19
Setting the electrode rinsing air	19
Functional check.....	20
General information	20
Troubleshooting	20

Start-up and powder coating	21
Shut-down.....	21
Cleaning and maintenance	23
General information	23
Cleaning.....	23
Gun cleaning	23
Cleaning the spray nozzle	24
Maintenance	24
Replacing parts.....	25
Dismantling the gun	25
General information	25
Dismantling procedure.....	26
Assembling the powder gun	31
Repairing the powder gun	31
Powder hose quick release connection.....	32
Troubleshooting	33
Spare parts list	35
Ordering spare parts.....	35
OptiGun GA03 – complete	36
OptiGun GA03 – gun body	37
OptiGun GA03 – shaft	38
OptiGun GA03-X – complete.....	39
OptiGun GA03-X – gun body.....	40
OptiGun GA03-X – Extension tube	41
OptiGun GA03-X – options when using several powder hoses	42
Gun cable	43
OptiGun GA03 – SuperCorona.....	44
OptiGun GA03 – angled nozzles.....	45
OptiGun GA03 – accessories	46
Flat jet nozzles – overview (wearing parts)	46
Round jet nozzles – overview (wearing parts).....	47
Gun extensions.....	48
Spray nozzles for extensions – overview (wearing parts)	49
Powder hoses – overview.....	50

Product description

Field of application

The OptiGun GA03 Automatic powder gun is built exclusively for the electrostatic coating with organic powders. Any other use is considered non-compliant. The manufacturer shall not be liable for damage resulting from such use; the user bears sole responsibility for such actions.



fig. 1: OptiGun GA03 automatic powder gun

Utilization



The Automatic gun type OptiGun GA03 is suited for the electrostatic coating of objects (in all shapes and geometries) that must be grounded.

Reasonably foreseeable misuse

- Coating of non grounded objects
- Use of enameled powder
- Incorrectly configured values for powder conveyance
- Incorrectly configured values for electrode rinsing air
- Use of moist powder

Technical Data

Electrical data

OptiGun GA03	
Nominal input voltage	12 V
Frequency	18 kHz (average)
Nominal output voltage	100 kV
Polarity	negative (optional positive)
Max. output current	100 µA
Ignition protection	Type A acc. EN 50177 Ex 2 mJ T6
Temperature range	0 °C - +40 °C (+32 °F - +104 °F)
Max. surface temperature	85 °C (+185 °F)
Protection type	IP64
Approvals	 0102  II 2D PTB 11 ATEX 5006-1

Dimensions

OptiGun GA03	
Weight	600 g

Processible powders

OptiGun GA03	
Plastic powder	yes
Metallic powder	yes
Enamel powder	no

ATTENTION

The OptiGun GA03 Automatic powder gun may only be connected to the following control units:

- OptiStar CG06, CG07, CG08, CG09, CG10, CG12, CG13 and MultiStar CG10!

Design and function

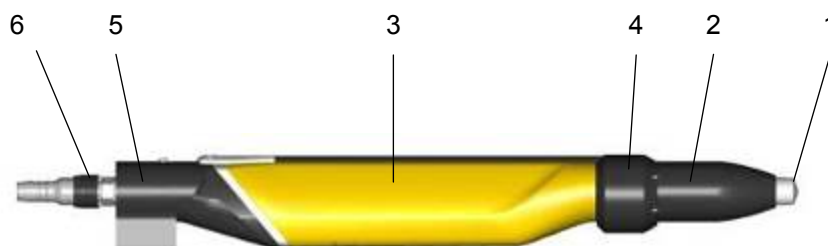

fig. 2: Structure

- | | | | |
|---|---|---|------------------|
| 1 | Spray nozzle | 4 | SuperCorona ring |
| 2 | Threaded sleeve | 5 | Gun fixture |
| 3 | Shaft with removable high voltage cascade | 6 | Clamp ring |

Scope of delivery

- OptiGun GA03 Automatic powder gun with gun cable (20 m)*, negative polarity
- Electrode rinsing air hose (20 m)*
- Flat jet nozzle NF27, complete (incl. electrode holder)
- Cable tie with Velcro closure
- Gun cleaning brush
- Spare parts kit
- Operating manual

* standard

Available accessories

- SuperCorona ring
- Flat jet nozzle (for specific applications)
- Round jet nozzles
- Gun extension 150 and 300 mm
- Angled nozzles 45°, 60° and 90°
- Gun cable extensions
- Powder tube extensions (when using several powder hoses)

For more information, see spare parts list!

SuperCorona ring

Field of application

The SuperCorona is an optional extension for the OptiGun GA03 Automatic powder gun, allowing for a better surface quality when coating with the powder coating equipment.

When coating wheel rims, drawers, radiators, lamps etc. the surface quality is exceptional, also in places with higher coating layer requirements. By coating with several powder types, an "orange peel" finish can be completely avoided. By coating with structure powder, the "picture frame effect" is hardly visible.

The performance of the OptiGun with SuperCorona is convincing due to its very good charging and very high deposition rate as well as an improved penetration into Faraday cages. The distance between nozzle and workpiece can be reduced to 100 mm without influencing the surface finish.



fig. 3: SuperCorona – retrofit

Due to its modular structure, the OptiGun Automatic powder gun can be extended quickly and easily with the lightweight SuperCorona (approx. 75 g). The OptiGun remains repair-friendly and easy to maintain even after reconfiguration.

SuperCorona assembly

Before fitting the SuperCorona ring, make sure that the connection and the plug-in connector are free from grease and powder, otherwise the electric contact cannot be guaranteed.

1.



2.

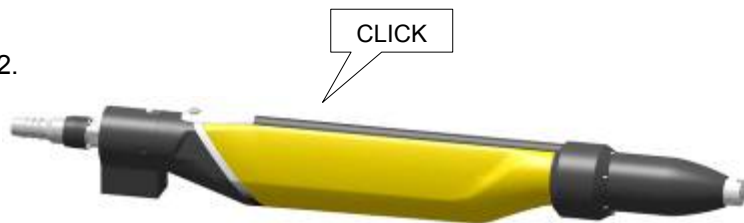

Principle of operation

High voltage generation

The control unit supplies a high-frequency low voltage signal of approx. 12 V eff. This voltage is fed through the gun cable (11) and the gun plug to the high voltage cascade (4) in the gun body.

In the high voltage cascade (2), the low voltage is high-transformed in a first step (c). This primary high voltage is subsequently rectified and multiplied in the high voltage cascade in a second step (d), until the required high voltage is obtained at the end (approx. 100 kV). The high voltage is now fed to the electrode (e) within the spray nozzle.

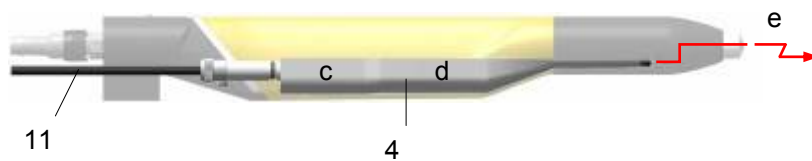

fig. 4: High voltage generation

Circuit

The OptiGun Automatic powder gun is switched on and off by the gun control module.

The control unit allows also the adjustment of low voltage, powder flow and electrode rinsing air to the gun.

Powder flow and electrode rinsing air

The electrode rinsing air is used by vented spray nozzles and is connected with its designated connection on the rear side of the gun control unit (see the operating manual of the gun control unit).

The functions of the spray nozzles are described in the following sections.

Spray nozzle

Flat jet nozzle with vented central electrode

The vented flat jet nozzle serves for the spraying and the charging of the powder. The powder is charged by the central electrode (**E**). The high voltage (**H**) created in the gun cascade is guided through the center electrode.

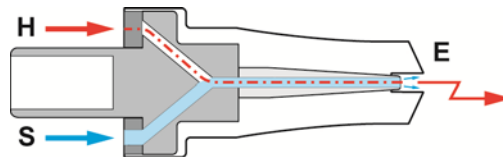

fig. 5: Flat jet nozzle with vented central electrode

In order to prevent powder from sintering on the electrode, compressed air is used during the spray process.

The electrode rinsing air (**S**) adjustment on the gun control unit is described in the corresponding operating manual.

Round jet nozzle with vented deflector and vented central electrode

The vented deflector is used, to give the powder stream emerging from the gun, a cloud formation. The powder is charged by the central electrode (**E**). The high voltage (**H**) created in the gun cascade is guided through the center electrode.

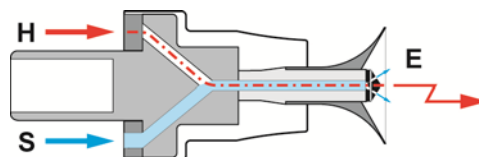

fig. 6: Round jet nozzle with vented deflector and vented central electrode

Since powder can accumulate on the baffle plate, it must be rinsed with compressed air.

The electrode rinsing air (**S**) adjustment on the gun control unit is described in the corresponding operating manual.

Typical characteristics – properties of the functions

- Continuous, tightly sealed gun body with separate channels for cascade and electrode rinsing air
- Quickly removable SuperCorona ring
- Powder tube coupling with quick-release fastener
- Covered hose and cable duct
- Simple conversion to a quick color change gun
- Easily dismountable by a few hand movements, therefore very easy to service
- Few wearing parts (nozzle and SuperCorona)
- Easily removable cascade because free of grease, with integrated current limiting resistors

Powder hose quick release connection

- Quick and simple connection and disconnection from powder hose and application cup



Connection for SuperCorona Ring

- Quick and simple connection to and disconnection from the SuperCorona ring



Start-up

Preparation for start-up

Basic conditions

When starting up the OptiGun GA03 Automatic powder gun, the following general conditions impacting the coating results must be taken into consideration:

- Gun correctly connected
- Gun control unit correctly connected
- Corresponding power and compressed air supply available
- Powder preparation and powder quality

Connect the OptiGun automatic powder gun

The OptiGun GA03 Automatic powder gun is delivered ready-to-use by the manufacturer. Just a few cables and hoses must be connected.



NOTE

The compressed air must be free of oil and water!

The gun is connected as follows:

1. Connect electrode rinsing air hose and powder hose to gun
2. Lay out gun cable, electrode rinsing air hose and powder hose and bind using Velcro strips (included)
3. Connect the gun cable plug to the socket **2.3** on the rear side of the control unit
4. Connect electrode rinsing air hose to coupling **1.4**
5. Connect powder hose to injector
6. Connect the gun plug to the gun control unit (see therefore the operating manual of the gun control unit)
7. Connect the electrode rinsing air hose of the control unit to the gun
8. Connect the powder hose from the gun to the injector

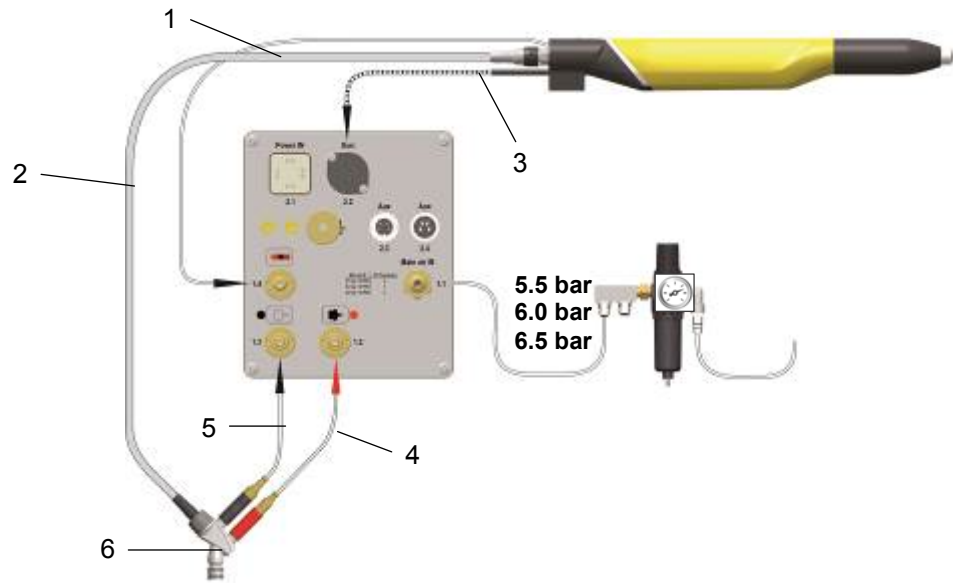

fig. 7: Connecting guide – overview

- | | | | |
|---|----------------------------|---|------------------------|
| 1 | Electrode rinsing air hose | 4 | Supplementary air hose |
| 2 | Powder hose | 5 | Conveying air hose |
| 3 | Gun cable | 6 | Injector |

Initial start-up



NOTE

If a malfunction occurs, see the troubleshooting guide, as well as the gun control unit operating manual!

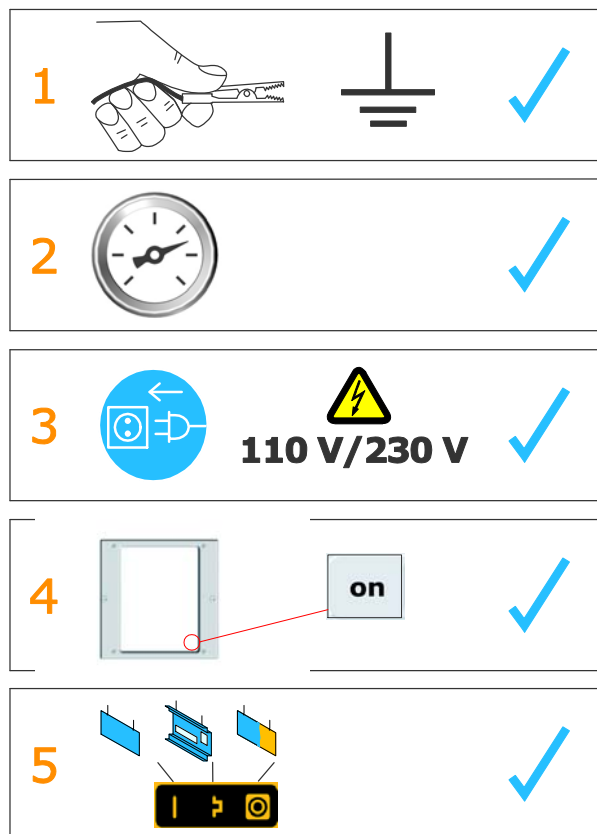

fig. 8:



NOTE

The remainder of the start-up procedure for the OptiGun GA03 gun is explicitly described in the operating instructions for the OptiStar gun control unit (chapter "Initial start-up" and "Daily start-up")!

Operation

⚠ WARNING

Touching the gun parts

During the coating process, the gun can discharge along the body of the coater if touching it.

- Do not touch any parts of the gun!

Setting of total air



correct powder cloud



too little total air

▶ NOTE

A total air volume of 4 Nm³/h and a 50% powder share are recommended as the base values.

The total air volume is depending on the powder hose length, the number of hose curvatures, the hose diameter, the conveying air pressure and the supplementary air. The operation mode of the injector and the effect of the supplementary air are described in the corresponding injector operating instructions.

▶ NOTE

The adjusted value of the total air volume can be left as it is, as long as the same diameter powder hose is used. If the hose diameter changes, the total air volume must be reset.

Setting the powder quantity

The powder output volume is selected in reference to the desired layer thickness. The selection is done on the control unit. For the beginning, the standard adjustment of 60% is recommended. The total air volume is thereby kept constant automatically.



NOTE

The powder output depends on the powder type and the adjusted total air volume (see therefore the control unit operating manual)!



much powder



little powder



NOTE

To achieve maximum efficiency, we recommend avoided an overly high powder volume where possible!

Setting the electrode rinsing air

1. Select the correct electrode rinsing

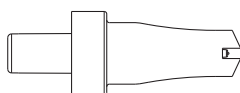

≈ 0.1 Nm³/h

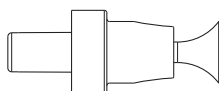

≈ 0.5 Nm³/h

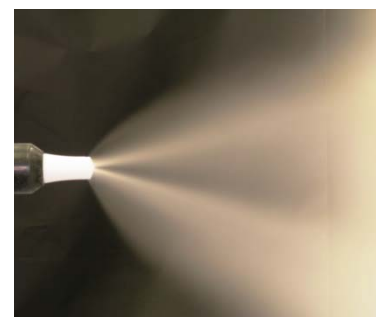

too much electrode rinsing air

2. Adjust the powder cloud with a test object

If flat jet nozzles are used:

1. Unscrew the threaded sleeve approx. 45°, so that the flat jet nozzle (or its extension) can be moved slightly
2. Turn the flat jet nozzle to desired axis direction
3. Tighten the threaded sleeve firmly again

ATTENTION**Threaded sleeve not tightened well**

If the spray nozzle is just fitted loosely, there is danger of a flash-over of the gun high voltage, which can damage the gun!

- Always tighten the threaded sleeve well!

If round jet nozzles with air rinsed deflectors are used:

4. Replace the deflector (Ø 16, 24 and 32 mm are supplied with the gun)

Functional check

General information

1. The installed gun must be pointed towards a grounded work piece in the coating booth. All connections must be attached!
2. Turn on the gun control unit (see also the control unit operating instructions) - the gun starts spraying
3. Adjust the desired coating parameters (powder volume, total air and high voltage) on the gun control unit (see also the control unit operating instructions)
4. Adjust the electrode rinsing air on the control unit dependent upon the nozzle used

If all tests have been completed positively, the gun is ready for operation. If malfunctions take place, the cause of the fault can be located by the corresponding troubleshooting guide.

Troubleshooting

If a malfunction occurs, see section "Troubleshooting". Please consider also the control unit operating instructions.

Start-up and powder coating

WARNING

Dangerous discharges.

If not grounded parts within 5 m of the coating booth are sufficient charged, this can cause dangerous discharges.

- All electrically conductive parts within 5 m of the coating booth must be grounded!

-
1. Check the powder fluidization
 2. The installed gun must be pointed towards a grounded work piece in the coating booth
 3. Switch on the gun control unit
 4. Adjust the coating parameters or select one of the programs. Check by observing the LED displays
 5. The workpieces can be coated now

Shut-down

1. Switch off the powder gun control unit. The adjustments for high voltage, powder output volume and electrode rinsing air remain stored.
2. If working interruptions take place, such as lunch time, night time etc. disconnect the main compressed air supply

Cleaning and maintenance

General information

ATTENTION

All unauthorized modifications to the gun are forbidden for safety reasons, and exempt the manufacturer from any liability from resulting damage!



NOTE

Regular, careful cleaning and maintenance extends the service life of the gun and ensures long-lasting, uniform coating quality!

- The parts to be replaced during maintenance work are available as spare parts. These parts can be found in the corresponding spare parts list!

Cleaning

Gun cleaning

ATTENTION

The following solvents may not be used to clean the gun:

- Ethylene chloride, acetone, ethyl acetate, methyl ethyl ketone, methylene chloride, premium gasoline, turpentine, tetrachloromethane, toluene, trichloroethylene, xylene!



NOTE

Only cleaning agents with a flash point of a least 5 Kelvin above the ambient temperature, or cleaning places with technical ventilation are allowed!



NOTE

Before cleaning the powder gun, switch off the control unit. The compressed air used for cleaning must be free of oil and water!

Daily

1. Blow off the outside of the gun and wipe, clean etc.

Weekly

2. Remove powder hose
3. Remove the spray nozzle from the gun and clean it with compressed air
4. Blow through the gun with compressed air, beginning from the connection in flow direction
5. Clean the integrated gun tube with the brush supplied, if necessary
6. Blow through the gun with compressed air again
7. Clean the powder hose
8. Reassemble the gun and connect it

Cleaning the spray nozzle**Daily or after every shift**

- Clean the inside and outside of the spray nozzle with compressed air.
Never immerse the parts in solvents!
- Check the seating of the spray nozzles.

ATTENTION**Threaded sleeve not tightened well**

If the spray nozzle is just fitted loosely, there is danger of a flash-over of the gun high voltage, which can damage the gun!

- Always tighten the threaded sleeve well!

Weekly:

- Remove the spray nozzle and clean on the inside with compressed air. If sinterings should have formed, then they have to be removed!

Monthly

- Check spray nozzle for wear

The flat jet nozzle is to be replaced, if:

- the spray pattern is no longer a regular oval
- deeper grooves are in the nozzle slot, or even the wall thickness is no longer recognizable
- the wedge of the electrode holder is worn

Nozzles with deflectors:

- if the wedge of the electrode holder is worn down, then the electrode holder is to be replaced

Maintenance

The gun is designed to require only a minimum amount of maintenance.

1. Clean the gun with dry cloth, see chapter "Maintenance"
2. Check connection points to powder house.

3. Replace the powder hoses, if necessary.

Replacing parts

Except for the replacement of possible defective parts, there are very few repairs to be made.



NOTE

The replacement of the cascade and the repair of the powder gun cable connection is only permitted by an authorized Gema Service center!

- Contact your Gema representative for details!
-

Dismantling the gun

General information



NOTE

The gun should only be dismantled, if this is required because of a defect or pollution.

- Dismantle the gun only so far, as the desired part is accessible!
-

WARNING

Touching the gun parts

During work on the gun, the gun can discharge along the body of the coater if touching it.

- Before dismantling the gun, switch off the control unit and disconnect the gun plug!
-

Dismantling procedure

1.



2.



3.



4.



5.



6.



7.



8.



9.



10.



11.



12.





17.

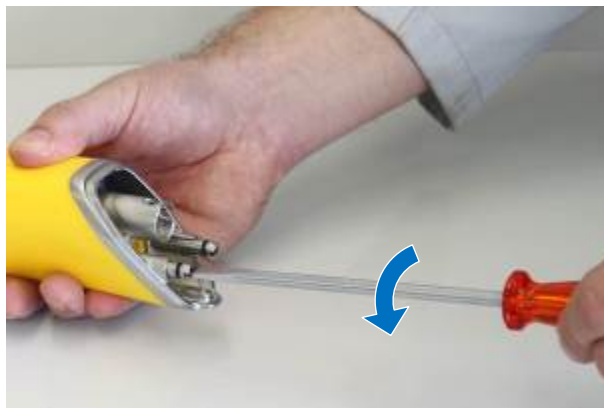

18.



19.



20.

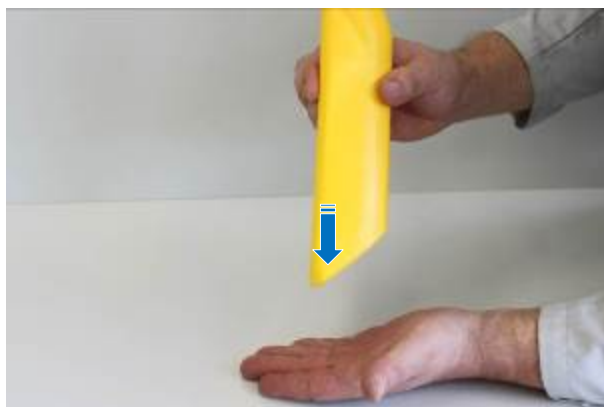

21.



22.

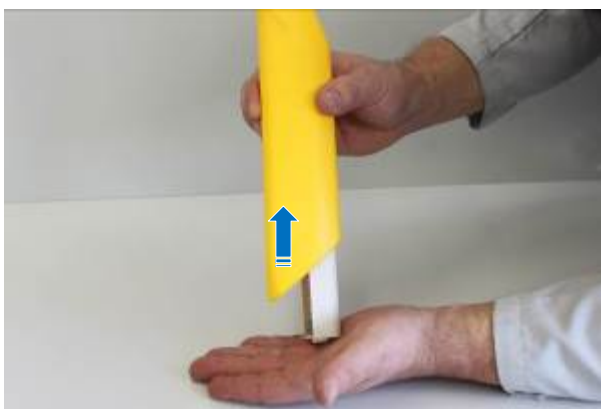

Assembling the powder gun

The assembling of the automatic gun is to be carried out in the reverse order to that shown above.

Repairing the powder gun

Apart from the replacement of possibly defective parts, hardly any repairs have to be made. The cascade can be replaced trouble-free. The repair of the gun cable connection, however, may only be made by an authorized Gema Service center.

Contact your Gema representative for details!

Powder hose quick release connection

The hose connection should be left on the powder hose, for as long as this is used, that means, if two sets of powder hoses are available, the double number of hose connections will be required.

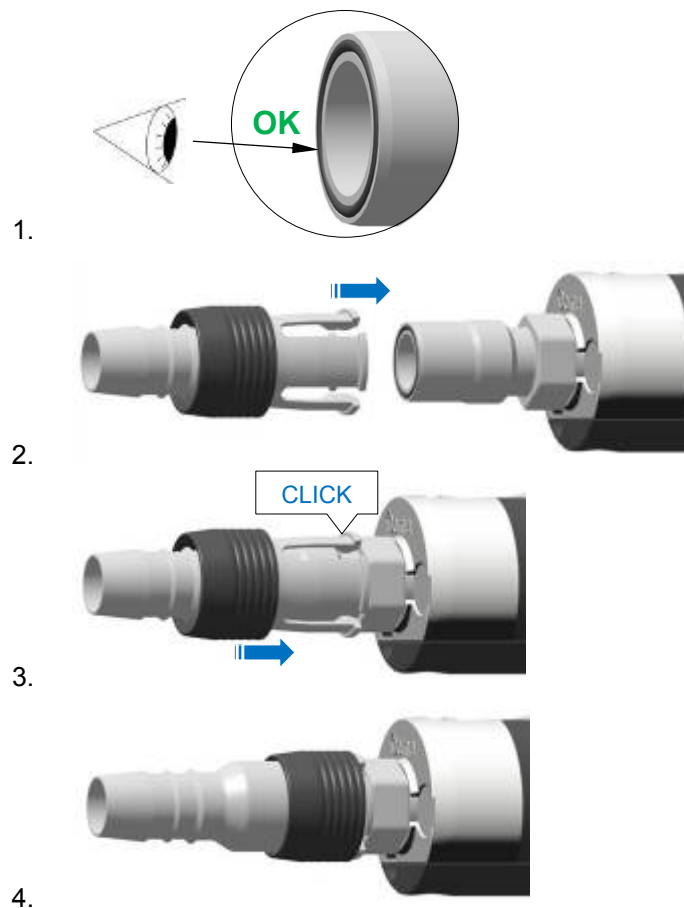

fig. 9: Powder hose quick release connection – Assembly

Troubleshooting



NOTE

Additional error descriptions are to be found also in the control unit operating instructions!

Fault	Causes	Corrective action
H11 (Help code on control unit)	Gun not connected	Connect the gun
	Gun plug or gun cable defective	Contact local Gema representative
	Remote control on powder gun defective	Contact local Gema representative
The powder gun does not spray powder, although the powder gun control unit is switched on	Compressed air not present	Connect the equipment to the compressed air
	Injector, check valve or throttle on injector, powder hose or powder gun clogged	Clean or replace the corresponding part
	Insert sleeve in injector is worn	Replace
	Insert sleeve in the injector is clogged	Clean/replace
	Pressure valve in the control unit defective	Replace
	Solenoid valve in the control unit defective	Replace
	Electronic board in the control unit defective	Contact local Gema representative
	No conveying air: - Throttle motor defective - Solenoid valve defective	Contact local Gema representative

Fault	Causes	Corrective action
Powder gun sprays powder, but the powder does not adhere to work-piece	High voltage and current deactivated or too low	Check the high voltage and current setting
	Gun cable (gun plug or gun connection) defective	Test the gun cable on another control unit
	High voltage cascade defective	Contact local Gema representative
	Electronic board in the OptiTronic defective	Send in for repair
Powder gun sprays powder, high voltage is available, powder does not adhere to work-piece	The objects are not properly grounded	Check the grounding
Gun achieving only poor spray profile	Total air incorrectly configured	Increase the powder quantity and/or total air volume on the control unit
	Bend or damage to air lines to injector	Check air lines to injector
	Insert sleeve in the injector worn or not inserted	Replace or insert it
	Fluidization not running	see above

Spare parts list

Ordering spare parts

When ordering spare parts for powder coating equipment, please indicate the following specifications:

- Type and serial number of your powder coating equipment
- Order number, quantity and description of each spare part

Example:

- **Type** OptiGun GA03 automatic powder gun,
Serial number 1234 5678
- **Order no.** 203 386, 1 piece, Clamp – Ø 18/15 mm

When ordering cable or hose material, the required length must also be given. The spare part numbers of this bulk stock is always marked with an *.

The wearing parts are always marked with a #. markiert.

All dimensions of plastic hoses are specified with the external and internal diameter:

Example:

Ø 8/6 mm, 8 mm outside diameter (o/d) / 6 mm inside diameter (i/d)

ATTENTION

Use of non-original Gema spare parts

When using the spare parts from other manufacturers the explosion protection is no longer guaranteed. **If any damage is caused by this use all guarantee claims become invalid!**

- Only original Gema spare parts should be used!
-

OptiGun GA03 – complete



NOTE

Only parts were included in the spare parts list, which the user can replace himself without problems!

- If the powder gun cable (4) is defective, it is to be completely sent in for repair!

	OptiGun GA03 Automatic powder gun – complete, polarity negative, incl. pos. 1-9	1010 198
	OptiGun GA03 Automatic powder gun – complete, polarity positive, incl. pos. 1-9	1010 199
1	Powder gun body OptiGun GA03 – complete, polarity negative	1008 726
	Powder gun body OptiGun GA03 – complete, polarity positive	1008 727
2	Threaded sleeve – see "Nozzle combinations" spare parts list	
3	Flat jet nozzle – complete, see "Nozzle combinations" spare parts list	
4	Gun cable – complete, 20 m, see also spare parts list "Gun cable"	1008 663
5	Cylinder screw – M8x50 mm	235 113
6	Washer – Ø 8.4/20x2 mm	215 880
7	Cable tie with Velcro closure (8x) (not shown)	303 070
8	Quick release connection – NW5, Ø 6 mm, for pos. 11 (not shown)	200 840
9	Cleaning brush – Ø 12 mm (not shown)	389 765
10	Powder hose – Ø 16/11 mm (not shown)	105 139*
11	Electrode rinsing air hose – Ø 6/4 mm (not shown)	103 144*

* Please indicate length

Wearing part

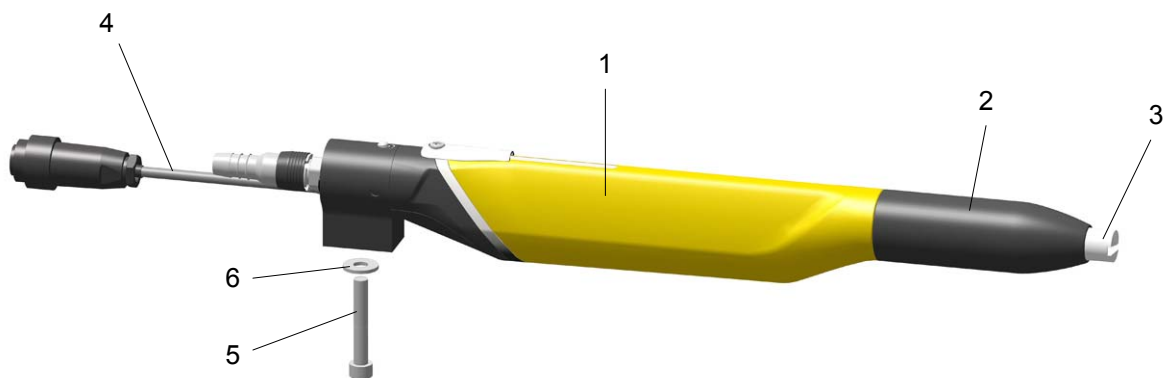

fig. 10: OptiGun GA03 – complete

OptiGun GA03 – gun body

1	OptiGun GA03 shaft – complete, negative polarity (see spare parts list "Shaft")	
	Powder tube – complete (incl. pos. 2-5)	1008 644#
2	Powder tube	1008 641#
3	O-ring – Ø 12x1 mm, FPM75	1006 324#
4	Hose holder	1008 642#
5	Clamp ring	1008 643
6	Gun fixture	1008 711
7	Ground plate	1011 457
8	SuperCorona connection	1009 764
9	Cylinder screw – M5x6 mm	263 907

Wearing part

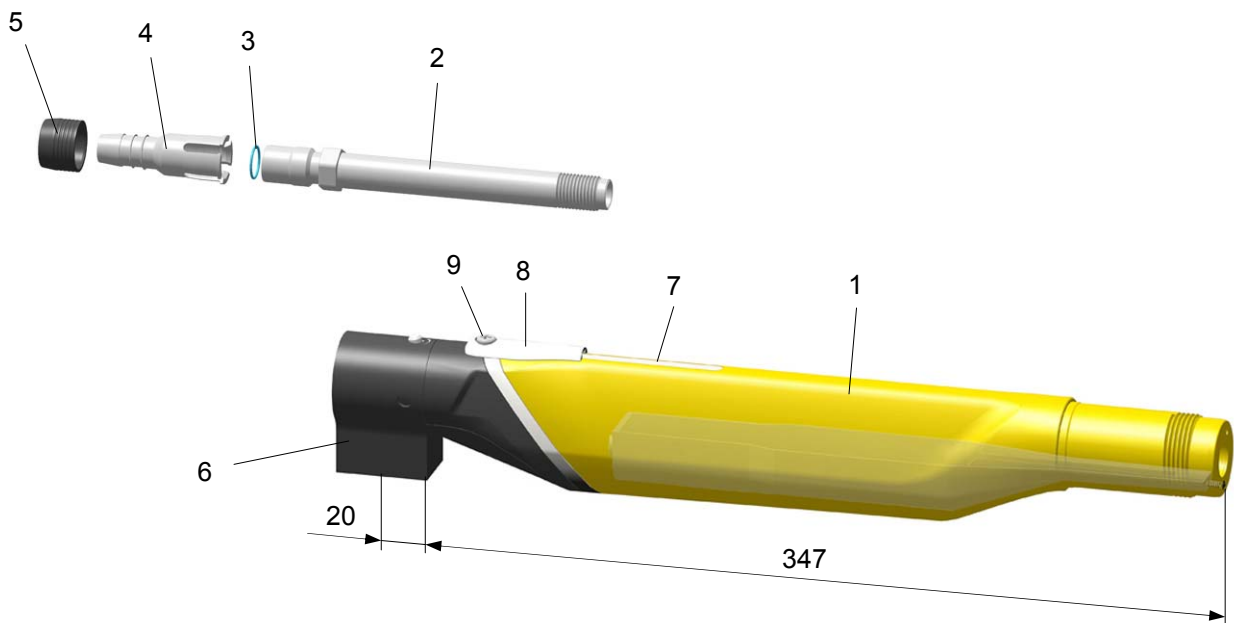

fig. 11: OptiGun GA03 – gun body

OptiGun GA03 – shaft

	Shaft OptiGun GA03 – complete, polarity negative, incl. pos. 1-9	1008 681
	Shaft OptiGun GA03 – complete, polarity positive, incl. pos. 1.1-9	1008 682
1	Cascade – complete, negative polarity	1007 231
1.1	Cascade – complete, positive polarity	1007 232
2	Shaft (without cascade)	1008 675
3	Sealing piece – complete (incl. pos. 6)	1008 690
6	Axial gasket	1008 687
8	Threaded bolt	1009 587
9	O-ring – Ø 4x1.5 mm	264 466
10	Gun rear end – complete (incl. pos. 10-13)	1008 701
11	Lock knob	382 833
12	Screw – M3x3 mm	266 795
13	Screw-in nipple – M7-Ø 6 mm	1008 699
14	Rear end cover	1008 697
15	Countersunk head screw – M4x6 mm	214 639

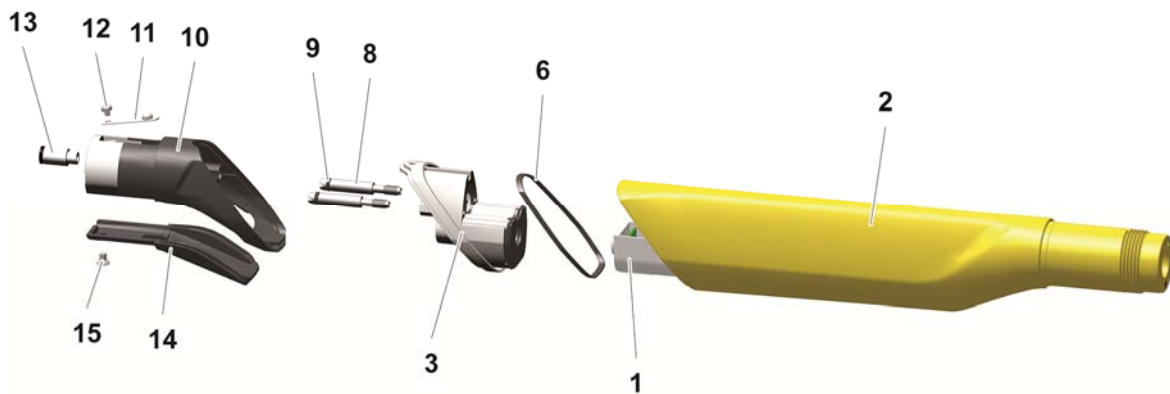

fig. 12: OptiGun GA03 – shaft

OptiGun GA03-X – complete

OptiGun GA03-X – Automatic powder gun – complete, polarity negative, incl. pos. 1-7	
	OptiGun GA03-700 1010 203
	OptiGun GA03-900 1010 204
	OptiGun GA03-1100 1010 205
	OptiGun GA03-1300 1010 206
	OptiGun GA03-1500 1010 207
	OptiGun GA03-1700 1010 208
	OptiGun GA03-1900 1010 209
	OptiGun GA03-2100 1010 210
1	OptiGun GA03-X gun body – complete, see "OptiGun GA03-X – gun body" spare parts list
2	Threaded sleeve – see "Nozzle combinations" spare parts list
3	Flat jet nozzle – complete, see "Nozzle combinations" spare parts list
4	Gun cable – complete, 20 m, see also spare parts list "Gun cable" 1008 663
5	Cable tie with Velcro closure (8x) (not shown) 303 070
6	Quick release connection – NW5, Ø 6 mm, for pos. 9 (not shown) 200 840
7	Cleaning brush – Ø 12 mm (not shown) 389 765
8	Powder hose – Ø 16/11 mm (not shown) 105 139*
9	Electrode rinsing air hose – Ø 6/4 mm (not shown) 103 144*

* Please indicate length

Wearing part



fig. 13: OptiGun GA03-X – complete

OptiGun GA03-X – gun body

	OptiGun GA03-X gun body – complete, polarity negative, incl. pos. 1-6	
	OptiGun GA03-700	1008 731
	OptiGun GA03-900	1008 732
	OptiGun GA03-1100	1008 733
	OptiGun GA03-1300	1008 734
	OptiGun GA03-1500	1008 735
	OptiGun GA03-1700	1008 736
	OptiGun GA03-1900	1008 737
	OptiGun GA03-2100	1008 738
1	OptiGun GA03 shaft – complete, negative polarity (see spare parts list "Shaft")	
	Powder tube – complete (incl. pos. 2-5)	1008 644#
2	Powder tube	1008 641#
3	O-ring – Ø 12x1 mm, FPM75	1006 324#
4	Hose holder	1008 642#
5	Clamp ring	1008 643
6	Ground plate	1011 457
7	SuperCorona connection	1009 764
8	Cylinder screw – M5x6 mm	263 907
9	Extension tube – see "OptiGun GA03-X – Extension tube" spare parts list	

Wearing part

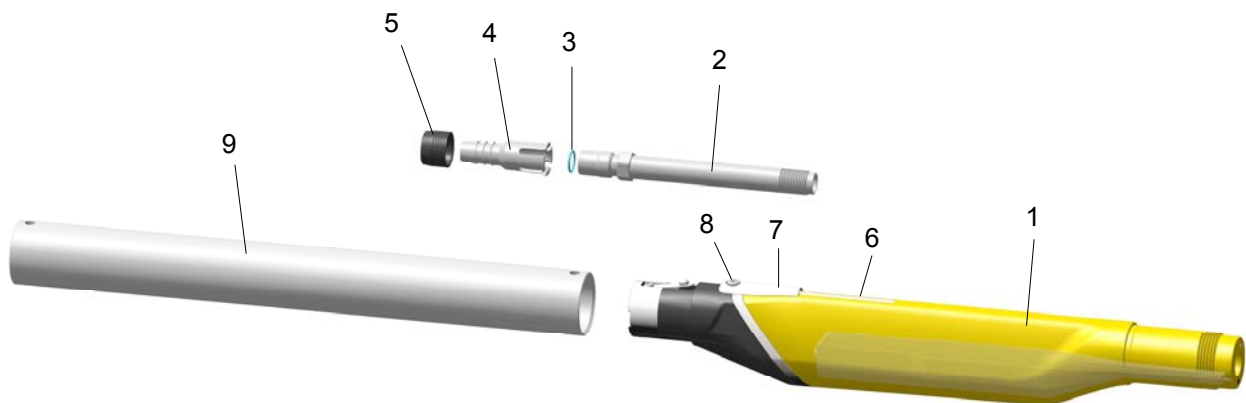

fig. 14: OptiGun GA03-X – gun body

OptiGun GA03-X – Extension tube

1	Extension tube for:	
	OptiGun GA03-700, L=711 mm	385 484
	OptiGun GA03-900, L=911 mm	385 476
	OptiGun GA03-1100, L=1111 mm	385 468
	OptiGun GA03-1300, L=1311 mm	385 450
	OptiGun GA03-1500, L=1511 mm	385 441
	OptiGun GA03-1700, L=1711 mm	384 682
	OptiGun GA03-1900, L=1911 mm	397 032
	OptiGun GA03-2100, L=2111 mm	397 040

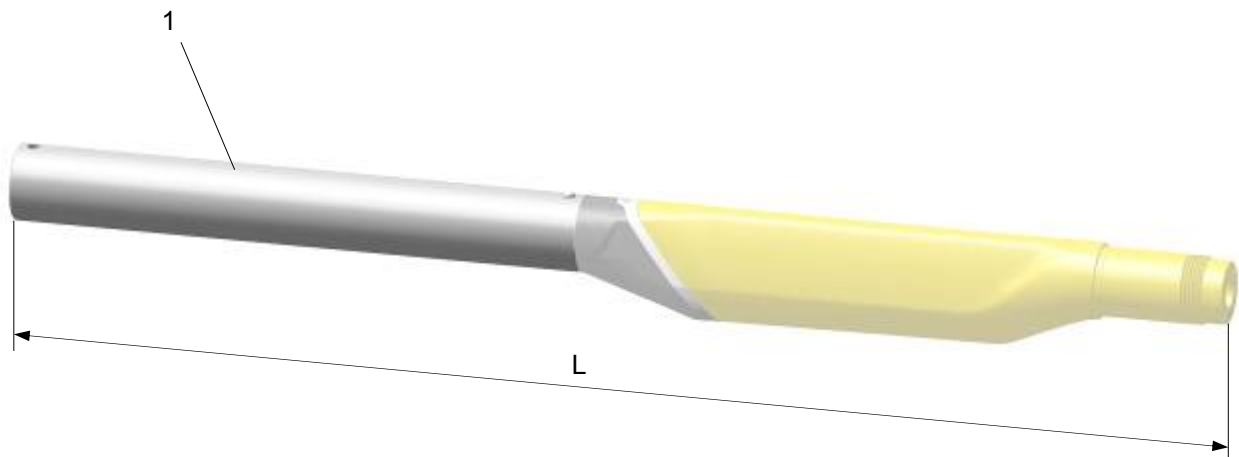

fig. 15: OptiGun GA03-X – Extension tube

OptiGun GA03-X – options when using several powder hoses

1	Powder tube extension for:	
	OptiGun GA03-700	1009 557#
	OptiGun GA03-900	1009 558#
	OptiGun GA03-1100	1009 559#
	OptiGun GA03-1300	1009 560#
	OptiGun GA03-1500	1009 561#
	OptiGun GA03-1700	1009 562#
	OptiGun GA03-1900	1009 563#
	OptiGun GA03-2100	1009 564#
2	Clamp ring	1008 643

Wearing part

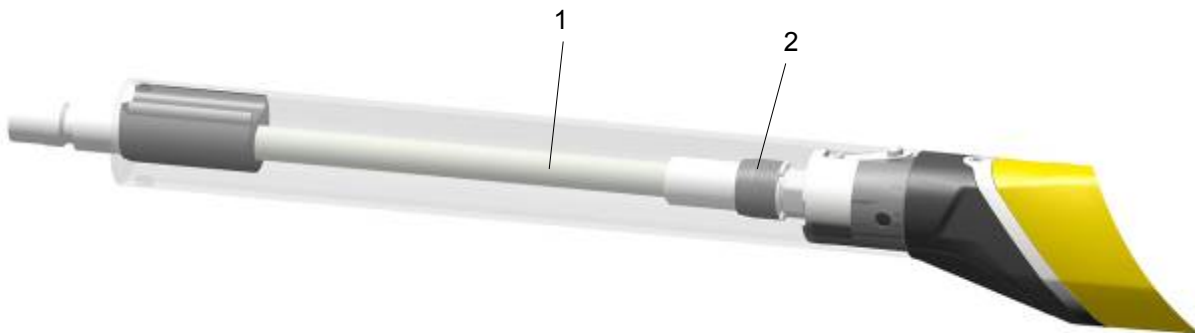

fig. 16: OptiGun GA03-X – options when using several powder hoses

Gun cable



NOTE

If the powder gun cable is defective, it is to be completely sent in for repair!

	Gun cable – complete, 11 m	1008 661
	Gun cable – complete, 15 m	1008 662
	Gun cable – complete, 20 m	1008 663
	Gun cable – complete, 30 m	1008 664
1	Cylinder screw – M4x6 mm	1008 639
2	O-ring – Ø 9.5x1.5 mm	1008 665
3	O-ring – Ø 8.5x1 mm	1008 666

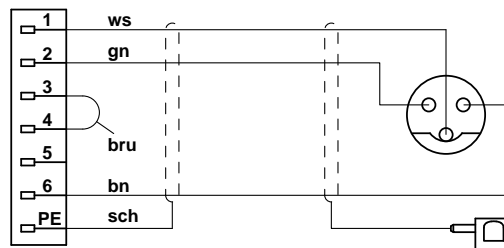

Pin allocation	
ws	white
gn	green
bru	Bridge
bn	brown
sch	Shield

fig. 17: Gun cable (complete)

OptiGun GA03 – SuperCorona

1	SuperCorona ring – complete	1009 761#
---	-----------------------------	-----------

Wearing part

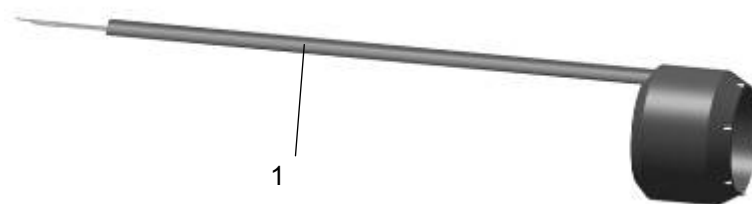

fig. 18: OptiGun GA03 – SuperCorona

OptiGun GA03 – angled nozzles

A	Angled body PA03-90° – complete (without pos. 4.1)	1009 139#
B	Angled body PA03-60° – complete (without pos. 4.1)	1009 138#
C	Angled body PA03-45° – complete (without pos. 4.1)	1009 137#
D	Extension PE09-090 – complete	1010 931#
	Extension PE09-120 – complete	1010 932#
	Extension PE09-180 – complete	1010 933#
1	PA03-90° knee piece – complete	1009 135#
2	PA03-60° knee piece – complete	1009 134#
3	PA03-45° knee piece – complete	1009 133#
4	Threaded sleeve	1009 128
4.1	Threaded sleeve for NF24 Flat jet nozzle	1012 654
5	Nozzle – see "OptiGun GA03 – accessories"	

Wearing part

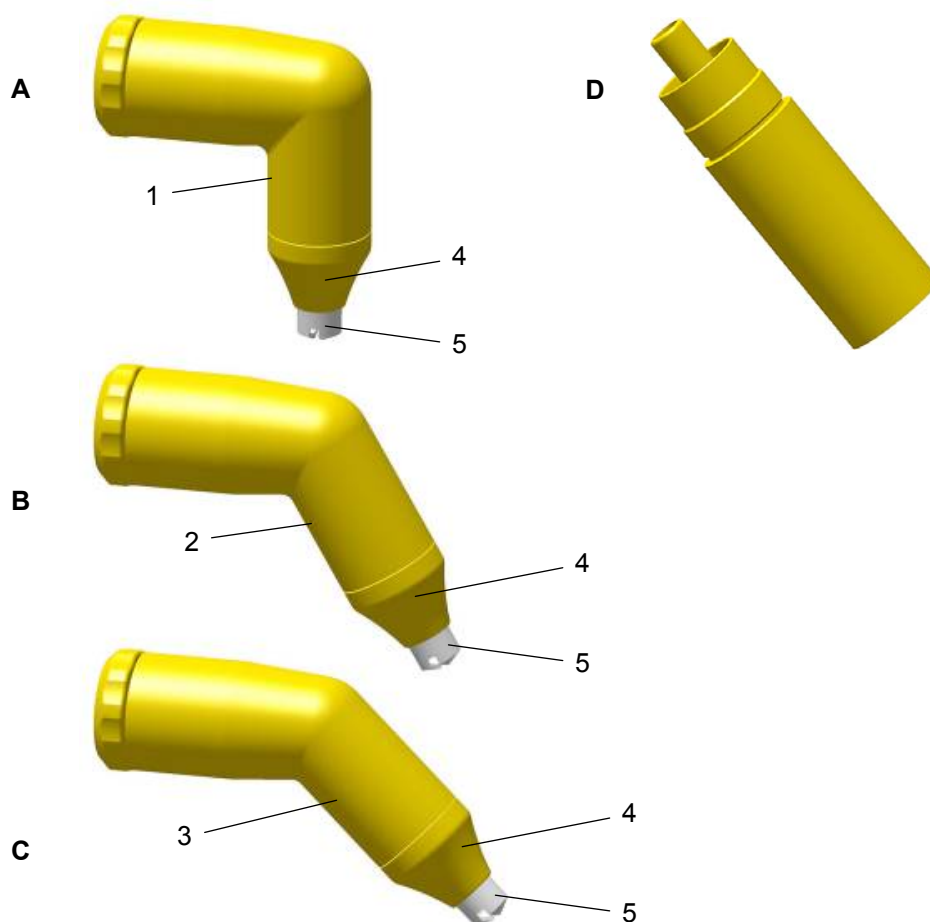









fig. 19: OptiGun GA03 – angled nozzles



OptiGun GA03 – accessories

Flat jet nozzles – overview (wearing parts)

Application	A	B	A + B	Threaded sleeve
Profiles/flat parts (standard nozzle)	 NF27 1010 752		NF27 1010 754	
Profiles/flat parts	 NF20 1010 090	 1007 683	NF20 1007 931	 1007 229
Complex profiles and depressions	 NF21 1007 935		NF21 1007 932	
Large surfaces	 NF24* 1008 147		NF24 1008 142	 1008 326

* not suitable for angled nozzles

Round jet nozzles – overview (wearing parts)

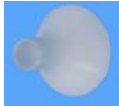
Application	A	B	A + B	Threaded sleeve	Deflectors
Suitable for large surfaces	 NS04 1008 151	 1008 152	NS04 1008 150	 1007 229	 Ø 16 mm 331 341
					Ø 24 mm 331 333
					Ø 32 mm 331 325
					Ø 50 mm 345 822







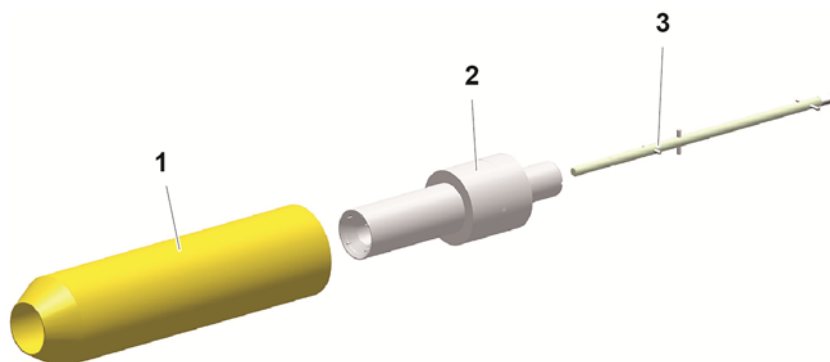

Round jet nozzle NS12-11

Round jet nozzle with 4 electrodes NS12-11 – complete, pos. 1, 2, 3	1010 922#
1 Threaded sleeve – complete	405 736
2 Muzzle NS12-11 – complete	1010 925#
3 Deflector rod – complete	1000 346#
4 Deflector – Ø 12 mm (not shown)	301 175#
4.1 Deflector – Ø 16 mm (not shown)	302 040#
4.2 Deflector – Ø 20 mm (not shown)	301 183#
4.3 Deflector – Ø 24 mm (not shown)	301 191#
4.1 Deflector – Ø 28 mm (not shown)	302 031#
4.4 Deflector – Ø 32 mm (not shown)	301 205#
4.5 Deflector – Ø 50 mm (not shown)	302 023#

Wearing part



Gun extensions

Gun extensions		
	L = 150 mm	L = 300 mm
without nozzle ¹	 1008 616	 1008 617
without nozzle ²	 1007 718	 1007 719
with Flat jet nozzle NF25	 1007 746	 1007 747
with Round jet nozzle NS09	 1007 748	 1007 749

¹ see NF27, NF20, NF21, NF24, NS04

² see NF25, NF26, NS09

ATTENTION

Connecting more than two extensions together

It is not permitted to connect more than two extensions together, in order to prevent the gun from being damaged by arising leverage force.

- The extensions (150 mm/300 mm) may be connected TO ONLY ONE ADDITIONAL extension (150 mm/300 mm), if necessary.





Spray nozzles for extensions – overview (wearing parts)



1007 718

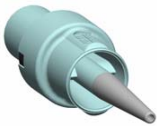
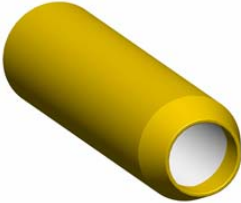

1007 719

Application	A	B	A + B	Threaded sleeve	Deflectors
Profiles/flat parts	 NF25 1007 735	 1007 684	NF25 1007 743	 1007 740	--
Complex profiles and depressions	 NF26 1007 742		NF26 1007 744		--
Suitable for large surfaces	 NS09 1008 257	 1008 258	NS09 1008 259		 Ø 16 mm 331 341 Ø 24 mm 331 333 Ø 32 mm 331 325 Ø 50 mm 345 822

Powder hoses – overview

Powder hose (antistatic)	Application	Diameter	Parts No.*	Material	Type
 <p> Ø 12/ 18 mm Typ 75 Material POE </p> <p> Ø 11/ 16 mm Typ 66 Material POE </p> <p> Ø 10/ 15 mm Typ 74 Material POE </p>	Fast color changes	Ø 11/16 mm	105 139	POE	66
	Fast color changes - low powder flow	Ø 10/15 mm	1001 673	POE	74
	Fast color changes - high powder flow	Ø 12/18 mm	1001 674	POE	75

* Please indicate length

